

CODE: BO-B6JE0656-WL

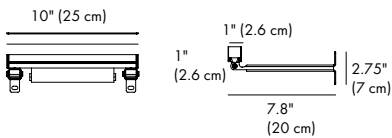

SMALL (S)



LIGHT SOURCE:

6 × 1W

LENS:

B38

SELECTED DEGREE:

30°(B38/30°)

INPUT VOLTAGE:

110-277V

OPERATING CURRENT:

30 mA

CONSUMPTION:

6.5W

LUMINANCE:

CW=540 | WW=432

IK:

02

CODE: BO-B6JE1256-WL



MEDIUM (M)

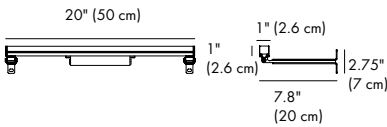

LIGHT SOURCE:

12 × 1W

LENS:

B38

SELECTED DEGREE:

30°(B38/30°)

INPUT VOLTAGE:

110-277V

OPERATING CURRENT:

65 mA

CONSUMPTION:

15W

LUMINANCE:

CW=1080 | WW=864

IK:

02

CODE: BO-B6JE2456-WL



LARGE (L)

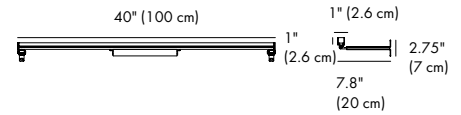

LIGHT SOURCE:

24 × 1W

LENS:

B38

SELECTED DEGREE:

30°(B38/30°)

INPUT VOLTAGE:

110-277V

OPERATING CURRENT:

135 mA

CONSUMPTION:

31.5W

LUMINANCE:

CW=2140 | WW=1976

IK:

02

WATER PROOF SOLUTION

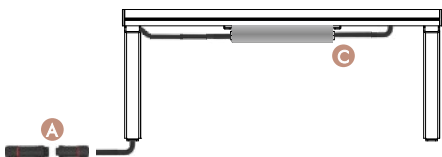

- B** IP67 Jiffy quick plug/socket connector (Option)
A IP-67 connector is as an optional assembly and ensures that water vapor will not enter into luminaires directly.
- C** High voltage driver IP65



sales@gordonbullarda.com
www.bullardoutdoor.com
1-877-964-4646



991 South Gull Lake Dr
Richland, MI 49083
USA

LIGHTING INFORMATION

HOUSING	Extruded aluminum anodized finishing
BRACKET	Aluminum anodized finishing
LIGHT WINDOW	Tempered glass, T=2mm
GASKET	Glass and housing are silicone sealed
LENS	OPTICS lens efficiency ≥ 85%
LED	Single color ORSAM LED
OPERATING TEMPERATURE	-20°C ~ 40°C
POWER CABLE	Outside of luminaire H05RN-F 3×1.0mm ² , L=0.5m 110-277V
DIMMING SUPPORT	Triac PWM Available 1-10V Dali Customized

OPTICS:

	B38	30°	40°	50°	60°	25°×50°
---	------------	-----	-----	-----	-----	---------

ANTI GLARE LOUVER (Optional)

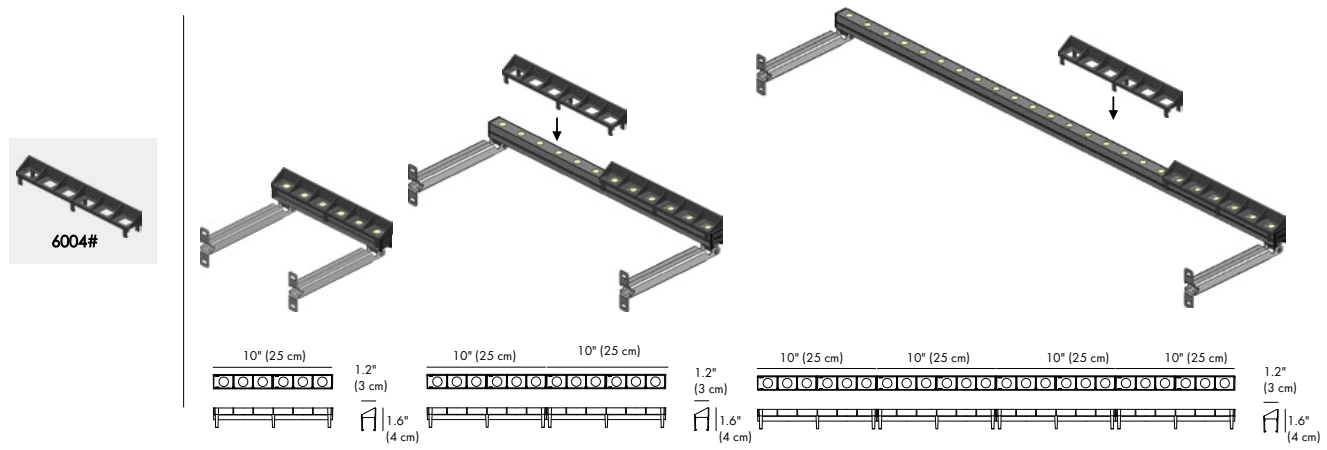

EXTERNAL BRACKET (Optional)



HIGH VOLTAGE INPUT (110V-277V) POWER CABLE WIRING TYPE

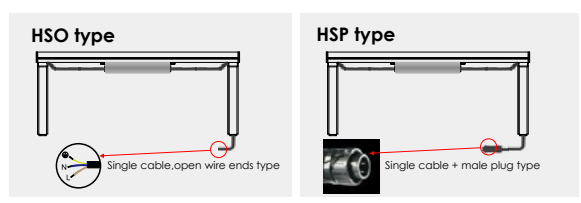

•High voltage input default: HSO type power cable, waterproof socket connector are not included(optional).

PHOTOMETRIC (Non anti glare louver)

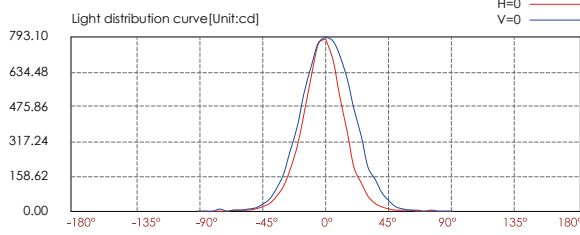
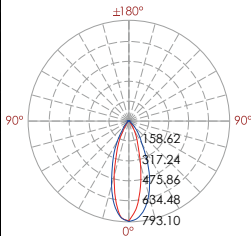
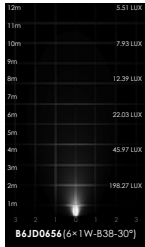

Lux distance curve

Illuminance at a distance			
Center beam LUX	Beam width		H
	V	H	
2m	198.27 LUX	1.1m	1.6m
4m	49.57 LUX	2.2m	3.1m
6m	22.03 LUX	3.3m	4.7m
8m	12.39 LUX	4.4m	6.3m
10m	7.93 LUX	5.5m	7.8m
12m	5.51 LUX	6.6m	9.4m

Ver.Spread: 30.7 Horiz.Spread: 42.9

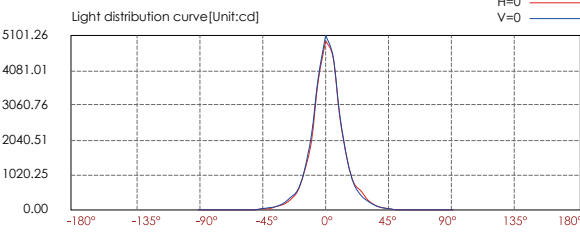
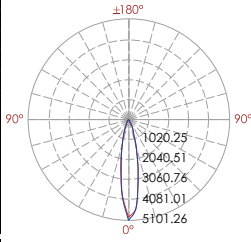
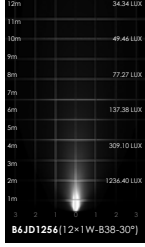

Lux distance curve

Illuminance at a distance			
Center beam LUX	Beam width		H
	V	H	
2m	1236.40 LUX	0.7m	0.7m
4m	309.10 LUX	1.3m	1.4m
6m	137.38 LUX	2.0m	2.1m
8m	77.27 LUX	2.7m	2.8m
10m	49.46 LUX	3.4m	3.5m
12m	34.34 LUX	4.0m	4.2m

Ver.Spread: 19.1 Horiz.Spread: 19.8

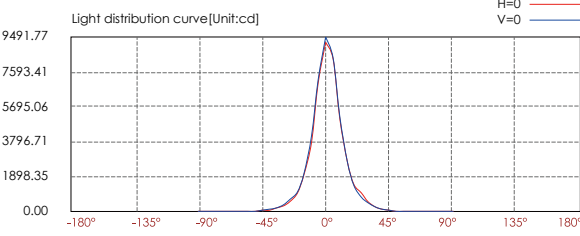
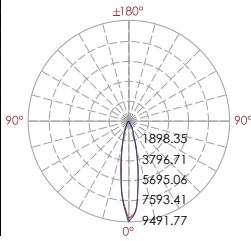

Lux distance curve

Illuminance at a distance			
Center beam LUX	Beam width		H
	V	H	
2m	2297.92 LUX	0.7m	0.7m
4m	574.48 LUX	1.4m	1.4m
6m	255.32 LUX	2.1m	2.1m
8m	143.62 LUX	2.8m	2.8m
10m	91.92 LUX	3.5m	3.5m
12m	63.83 LUX	4.2m	4.2m

Ver.Spread: 20.0 Horiz.Spread: 20.0

NELL COLLECTION

CODE: BO-B6JE0656-WL



CODE: BO-B6JE1256-WL



CODE: BO-B6JE2456-WL



HOW TO ORDER:

CODE:

EXAMPLE:

BO-B6JE0656-WL-6004#-L40

BO-B6JE0656-WL-6004#-L40

1. CHOOSE FIXTURE SIZE:

BO-B6JE0656-WL

BO-B6JE1256-WL

BO-B6JE2456-WL

2. ANTI GLARE LOUVER (Optional)

6004#



2. ANTI GLARE LOUVER (Optional)

L40



sales@gordonbullarda.com

www.bullardoutdoor.com

1-877-964-4646



991 South Gull Lake Dr

Richland, MI 49083

USA