

CODE: BO-B6KE0657-WL

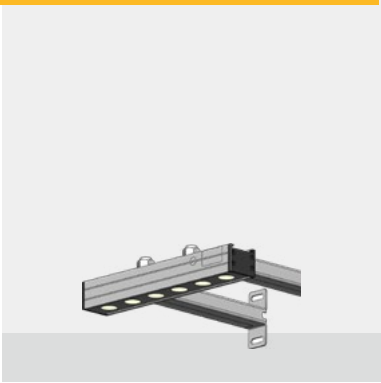

**SMALL (S)**

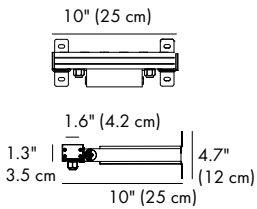

**LIGHT SOURCE:**

6 × 1.8W

**LENS:**

B17

**SELECTED DEGREE:**

20°(B17/20°)

**INPUT VOLTAGE:**

110-277V

**OPERATING CURRENT:**

50 mA

**CONSUMPTION:**

11.2W

**LUMINANCE:**

CW=760 | WW=700

**IK:**

05

CODE: BO-B6KE1257-WL

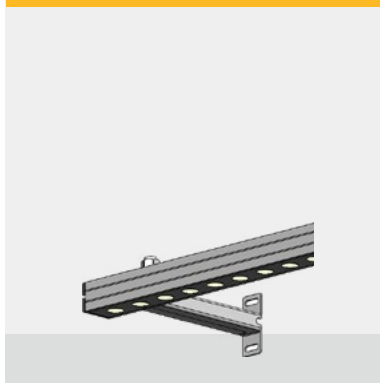

**MEDIUM (M)**

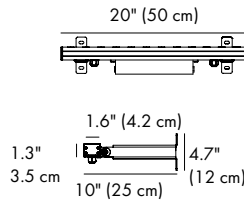

**LIGHT SOURCE:**

12 × 1.5W

**LENS:**

B17

**SELECTED DEGREE:**

20°(B17/20°)

**INPUT VOLTAGE:**

110-277V

**OPERATING CURRENT:**

109 mA

**CONSUMPTION:**

25.5W

**LUMINANCE:**

CW=1637 | WW=1392

**IK:**

05

CODE: BO-B6KE2457-WL

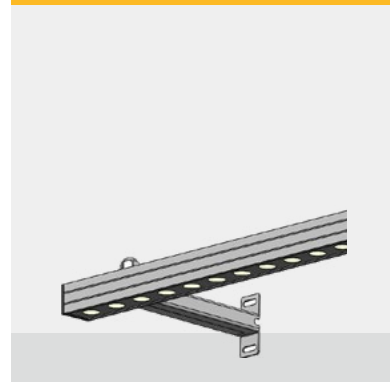

**LARGE (M)**

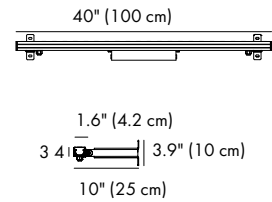

**LIGHT SOURCE:**

24 × 1.5W

**LENS:**

B17

**SELECTED DEGREE:**

20°(B17/20°)

**INPUT VOLTAGE:**

110-277V

**OPERATING CURRENT:**

212 mA

**CONSUMPTION:**

548.3W

**LUMINANCE:**

CW=3270 | WW=2780

**IK:**

05

**WATER PROOF SOLUTION**

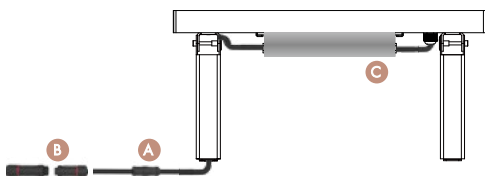

- A Water-Stopper**(Included)  
A IP-65 water-stopper is added in the end of luminaires as standard assembly which is also an important system for water resistance.
- B IP67 Jiffy quick plug/socket connector**(Option)  
A IP-67 connector is as an optional assembly and ensures that water vapor will not enter into luminaires directly.
- C High voltage driver** IP65



sales@gordonbullarda.com  
www.bullardoutdoor.com  
1-877-964-4646



991 South Gull Lake Dr  
Richland, MI 49083  
USA

**LIGHTING INFORMATION**

<b>HOUSING</b>	Extruded aluminum anodized finishing
<b>BRACKET</b>	Aluminum anodized finishing
<b>LIGHT WINDOW</b>	Tempered glass, T=2mm
<b>GASKET</b>	Glass and housing are silicone sealed
<b>LENS</b>	OPTICS lens efficiency ≥ 85%
<b>LED</b>	Single color ORSAM LED
<b>OPERATING TEMPERATURE</b>	-20°C ~ 40°C
<b>POWER CABLE</b>	Outside of luminaire H05RN-F 3×1.0mm <sup>2</sup> , L=0.5m 110-277V
<b>DIMMING SUPPORT</b>	Triac PWM Available 1-10V Dali Customized

**OPTICS:**



B17

15° 20° 30° 45°

**ANTI GLARE LOUVER (Optional)**

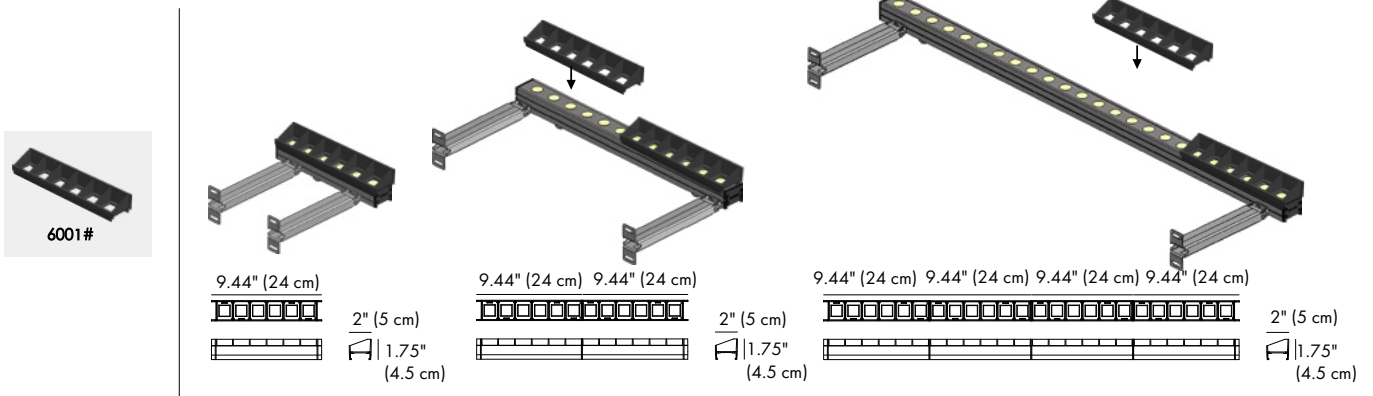

**EXTERNAL BRACKET (Optional)**

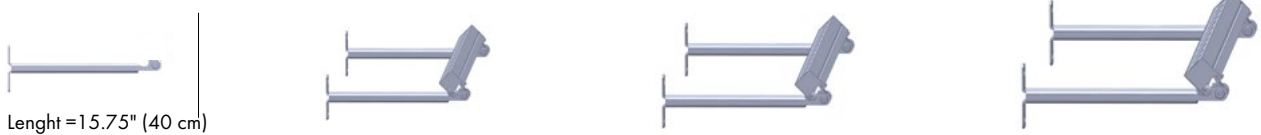

**HIGH VOLTAGE INPUT (110V-277V) POWER CABLE WIRING TYPE**

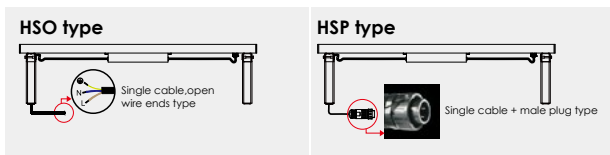

- High voltage input default: Single HSO type power cable, waterproof plugs are not included.
- (Other power cable type and plugs are optional)

sales@gordonbullarda.com  
www.bullardoutdoor.com



991 South Gull Lake Dr  
Richland, MI 49083  
USA

1-877-964-4646

**PHOTOMETRIC (Non anti glare louver)**

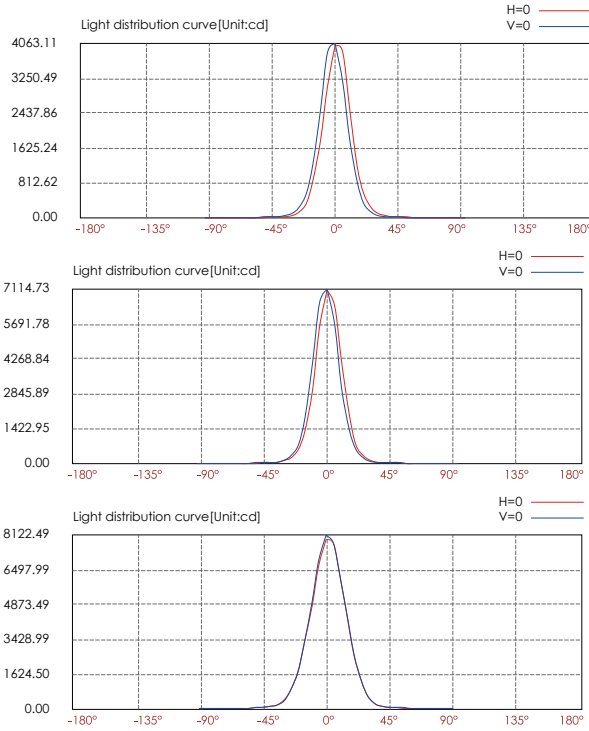
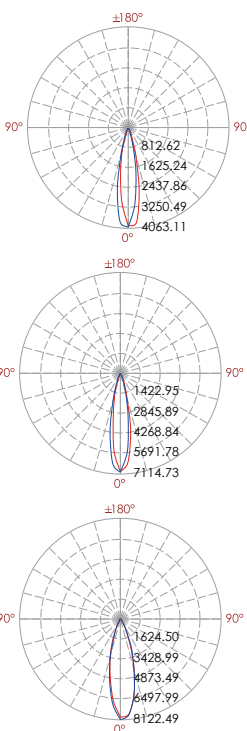
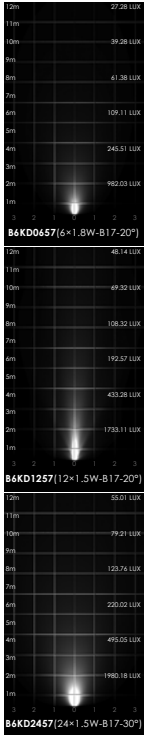

**Lux distance cure**

illuminance at a distance

Center beam LUX	Beam width V	H
2m 982.03 LUX	0.7m	0.8m
4m 245.51 LUX	1.5m	1.5m
6m 109.11 LUX	2.2m	2.3m
8m 61.38 LUX	3.0m	3.0m
10m 39.28 LUX	3.7m	3.8m
12m 27.28 LUX	4.5m	4.5m

Ver.Spread: 21.2 Horiz.Spread: 21.4

**Lux distance cure**

illuminance at a distance

Center beam LUX	Beam width V	H
2m 1733.11 LUX	0.7m	0.7m
4m 433.28 LUX	1.4m	1.4m
6m 192.57 LUX	2.2m	2.2m
8m 108.32 LUX	2.9m	2.9m
10m 69.32 LUX	3.6m	3.6m
12m 48.14 LUX	4.3m	4.3m

Ver.Spread: 20.5 Horiz.Spread: 20.6

**Lux distance cure**

illuminance at a distance

Center beam LUX	Beam width V	H
2m 1980.18 LUX	1.0m	1.0m
4m 495.05 LUX	2.0m	2.0m
6m 220.02 LUX	2.9m	3.0m
8m 123.76 LUX	3.9m	4.0m
10m 79.21 LUX	4.9m	5.0m
12m 55.01 LUX	5.9m	6.0m

Ver.Spread: 27.6 Horiz.Spread: 27.9

sales@gordonbullarda.com  
www.bullardoutdoor.com  
1-877-964-4646



991 South Gull Lake Dr  
Richland, MI 49083  
USA

Due to the dynamic nature of lighting products and the associated technologies, luminaire data on all sheet sheets is subject to change at the discretion of Gordon Bullard LLC and associated companies.

# SENTO COLLECTION

CODE: BO-B6KE0657-WL



CODE: BO-B6KE1257-WL



CODE: BO-B6KE2457-WL



## HOW TO ORDER:

CODE:

**EXAMPLE:**

BO-B6KE0657-WL-6001#-L40

BO-B6KE0657-WL-6001#-L40

### 1. CHOOSE FIXTURE SIZE:

BO-B6KE0657-WL

BO-B6KE1257-WL

BO-B6KE2457-WL

### 2. ANTI GLARE LOUVER (Optional)

6001#

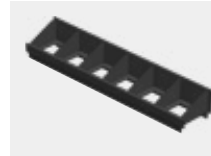

### 2. ANTI GLARE LOUVER (Optional)

L40



sales@gordonbullarda.com

www.bullardoutdoor.com

1-877-964-4646



991 South Gull Lake Dr

Richland, MI 49083

USA