

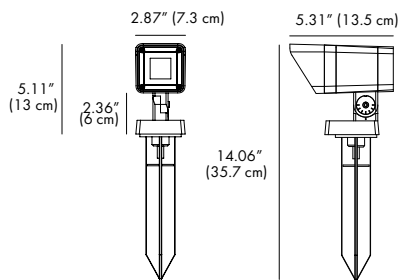

CODE: BO-B3DVB0127-SP



SMALL (S)



LIGHT SOURCE:

1x8W

LENS:

B71

SELECTED DEGREE:

24°

INPUT VOLTAGE:

110-277V

OPERATION CURRENT:

45 mA

CONSUMPTION:

10 W

LUMINANCE:

792 lm

CODE: BO-B3DWB0460-SP



MEDIUM (M)

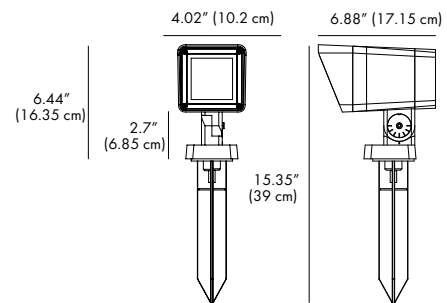

LIGHT SOURCE:

4x4W

LENS:

FB11B4

SELECTED DEGREE:

20°

INPUT VOLTAGE:

110-277V

OPERATION CURRENT:

78 mA

CONSUMPTION:

17.4 W

LUMINANCE:

1227 lm



sales@gordonbullard.com

www.bullardoutdoor.com

1-877-964-4646



991 South Gull Lake Dr

Richland, MI 49083

USA

LIGHTING INFORMATION



HOUSING	12# Die-casting aluminium finishing or powder painting T=60-80µm. Adhesion of ISO class 1/ASTM class 4B
LIGHT WINDOW	Tempered glass, T=3mm
LED	NICHIA
LED DRIVER	Constant Voltage Input, Constant Current Output
CABLE GLAND	IP68 PG-9 PA66
GASKET	Tooling shaped seal
POWER CABLE	Outside of luminaire 110-277V: H05RN-F 3×1.0mm ² , L=2.0m

REGULAR PAINTING COLOR

Basic		Secondary	
	Dark Grey KAP 7037		Silver Grey KAP 9022
			Sanded Black RAL 9005

OPTICS

Referenced Degree(°)θ1/2

	B71	15°	24°	33°	45°	60°
	FB11B4	9°	15°	20°	30°	45° 60°

ADJUSTABLE BEAM DIRECTION

Approximately

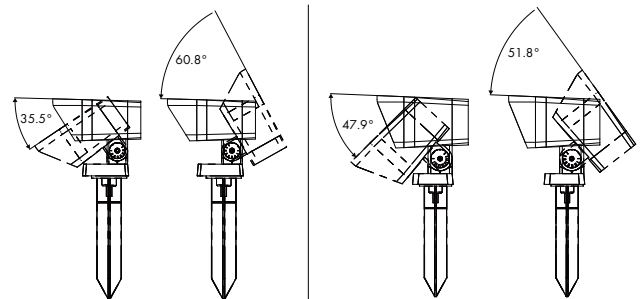

ACCESSORIES

SPIKE

STAINLESS STEEL



I'D	Fitted Item
12A	BO-B3DVB0127-SP BO-B3DWB0460-SP



PC/ABS alloys



I'D	Fitted Item
18A	BO-B3DVB0127-SP BO-B3DWB0460-SP



TREE POLE STRAP

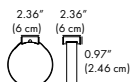

I'D	Fitted Item
RD003	BO-B3DVB0127-SP BO-B3DWB0460-SP



WATER PROOF SOLUTION

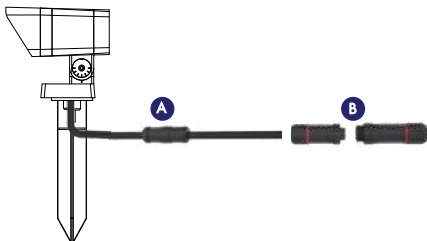

A Water-Stopper (Included)

A IP-66 water-stopper is added in the end of luminaires as standard assembly which is also an important system for water resistance.

B IP67 Jiffy quick plug/socket connector (Option)

A IP-67 connector is as an optional assembly and ensures that water vapor will not enter into luminaires directly.

PHOTOMETRIC

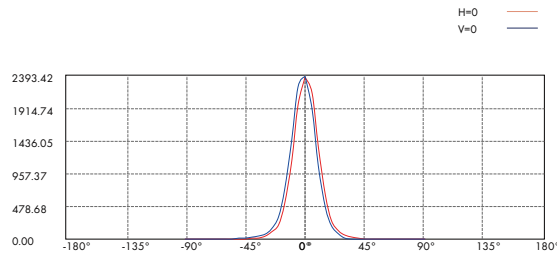
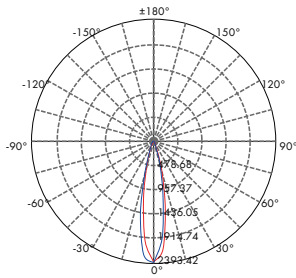
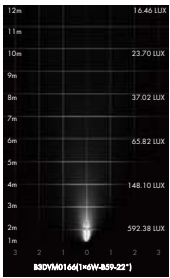

Lux distance Curve

Center Beam LUX	Beam Width	
	V	H
2m	0.7m	0.7m
4m	1.5m	1.5m
6m	2.2m	2.2m
8m	3.0m	3.0m
10m	3.7m	3.7m
12m	4.4m	4.5m

Vert.Spread:20.9 Horiz.Spread:21.2

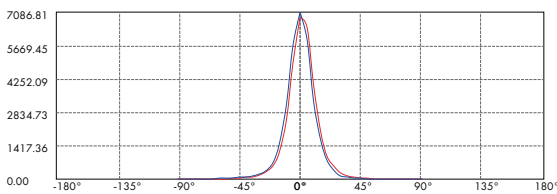
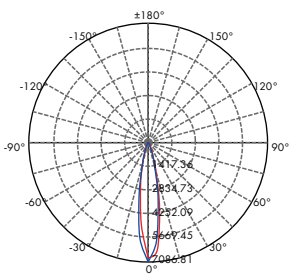
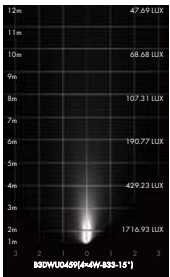

Lux distance Curve

Center Beam LUX	Beam Width	
	V	H
2m	0.7m	0.7m
4m	1.3m	1.3m
6m	2.0m	2.0m
8m	2.7m	2.7m
10m	3.4m	3.3m
12m	4.0m	4.0m

Vert.Spread:19.1 Horiz.Spread:18.8

sales@gordonbullard.com

www.bullardoutdoor.com

1-877-964-4646



991 South Gull Lake Dr

Richland, MI 49083

USA

HOW TO ORDER:

CODE:

CODE: BO-B3DVB0127-SP



SMALL (S)

CODE: BO-B3DWB0460-SP



MEDIUM (M)

EXAMPLE:



BO-B3DVB0127-SP-KAP7037-RD003-A-B

1. CHOOSE FIXTURE SIZE:

BO-B3DVB0127-SP SMALL

BO-B3DWB0460-SP MEDIUM

2. BODY FINISH OPTIONS:

-  -KAP 7037 Dark Grey
-  -KAP 9022 Silver Grey
-  -RAL 9005 Sanded Black

3. SPIKE (OPTIONAL):

STAINLESS STEEL:

-12A

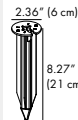

I'D	Fitted Item
12A	BO-B3DVB0127-SP BO-B3DWB0460-SP



PC/ABS alloys:

-18A

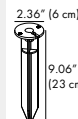

I'D	Fitted Item
18A	BO-B3DVB0127-SP BO-B3DWB0460-SP



sales@gordonbullard.com

www.bullardoutdoor.com

1-877-964-4646



991 South Gull Lake Dr

Richland, MI 49083

USA

HOW TO ORDER:

CODE:

CODE: BO-B3DVB0127-SP



SMALL (S)

CODE: BO-B3DWU0460-SP



MEDIUM (M)

EXAMPLE:

BO-B3DVB0127-SP-KAP7037-RD003-A-B

4. TREE POLE STRAP:

-RD003



I'D Fitted Item

RD003 BO-B3DVB0127-SP
BO-B3DWB0460-SP



5. WATER PROOF SOLUTION (included):

-A **Water-Stopper** (Included)

A IP-66 water-stopper is added in the end of luminaires as standard assembly which is also an important system for water resistance.

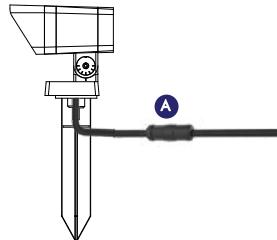

6. WATER PROOF SOLUTION (optional):

-B **IP67 Jiffy quick plug/socket connector** (Option)

A IP-67 connector is as an optional assembly and ensures that water vapor will not enter into luminaires directly.

