

CODE: BO-B6KD0657 -WL

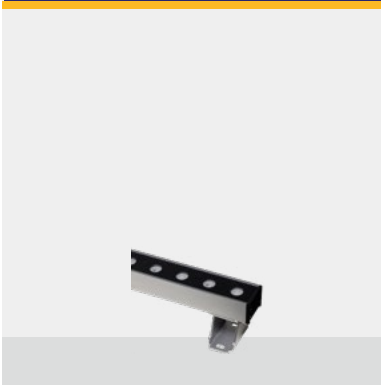

SMALL (S)

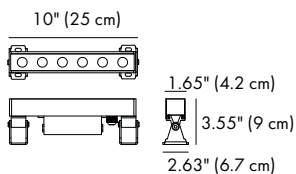

**LIGHT SOURCE:**

6 × 1.8W

**LENS:**

B17

**SELECTED DEGREE:**

20°(B17/20°)

**INPUT VOLTAGE:**

110-277V

**OPERATING CURRENT:**

50 mA

**CONSUMPTION:**

11.2W

**LUMINANCE:**

CW=760 | WW=700

**IK:**

05

CODE: BO-B6KD1257-WL

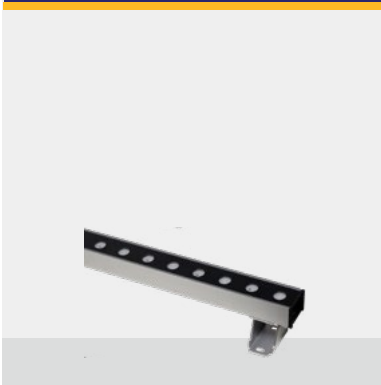

MEDIUM (M)

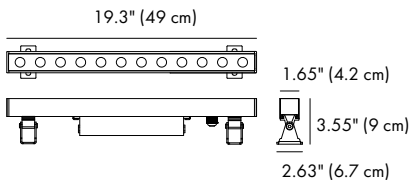

**LIGHT SOURCE:**

12 × 1.5W

**LENS:**

B17

**SELECTED DEGREE:**

20°(B17/20°)

**INPUT VOLTAGE:**

110-277V

**OPERATING CURRENT:**

109 mA

**CONSUMPTION:**

25.5W

**LUMINANCE:**

CW=1637 | WW=1392

**IK:**

05

CODE: BO-B6KD2457-WL

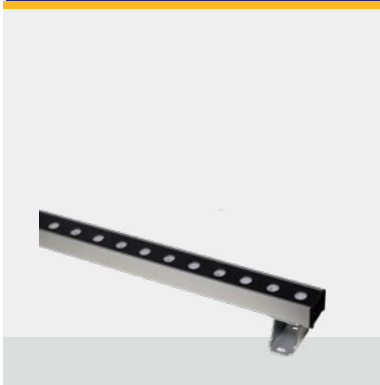

LARGE (M)

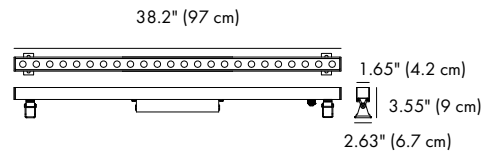

**LIGHT SOURCE:**

24 × 1.5W

**LENS:**

B17

**SELECTED DEGREE:**

20°(B17/20°)

**INPUT VOLTAGE:**

110-277V

**OPERATING CURRENT:**

212 mA

**CONSUMPTION:**

48.3W

**LUMINANCE:**

CW=3270 | WW=2780

**IK:**

05

**WATER PROOF SOLUTION**

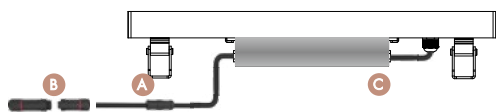

- A Water-Stopper(Included)**  
A IP-65 water-stopper is added in the end of luminaires as standard assembly which is also an important system for water resistance.
- B IP67 Jiffy quick plug/socket connector (Option)**  
A IP-67 connector is as an optional assembly and ensures that water vapor will not enter into luminaires directly.
- C High voltage driver IP65**



sales@gordonbullarda.com  
www.bullardoutdoor.com  
1-877-964-4646



991 South Gull Lake Dr  
Richland, MI 49083  
USA

## LIGHTING INFORMATION

<b>HOUSING</b>	Extruded aluminum anodized finishing
<b>BRACKET</b>	Aluminum anodized finishing
<b>LIGHT WINDOW</b>	Tempered glass, T=2mm
<b>GASKET</b>	Glass and housing are silicone sealed
<b>LENS</b>	OPTICS lens efficiency ≥ 85%
<b>LED</b>	Single color ORSAM LED
<b>CCT</b>	3000K / 3500K / 4000K / 5000K / Custom on request
<b>CRI</b>	90
<b>OPERATING TEMPERATURE</b>	-20°C ~ 40°C
<b>POWER CABLE</b>	Outside of luminaire H05RN-F 3×1.0mm², L=0.5m 110-277V
<b>DIMMING SUPPORT</b>	Triac PWM Available, 1-10V, Dali, Customized

## OPTICS:



## ANTI GLARE LOUVER (Optional)

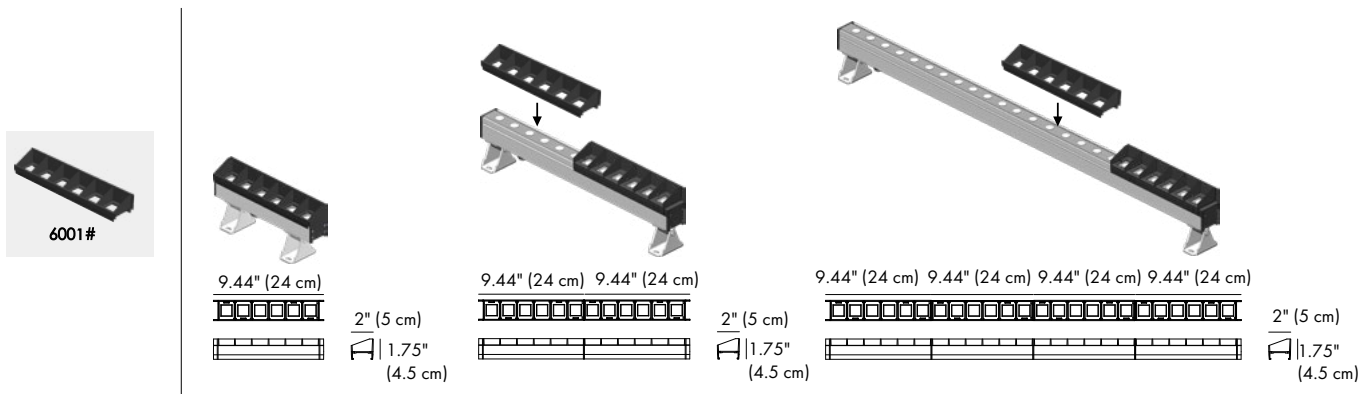

## HIGH VOLTAGE INPUT (110V-277V) POWER CALBE WIRING TYPE

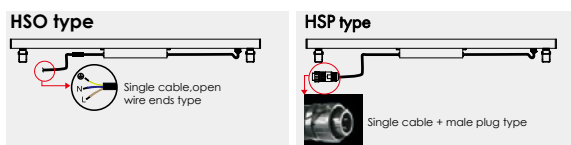

• **High voltage input default:** Single HSO type power cable, waterproof plugs are not included.  
(Other power cable type and plugs are optional)

sales@gordonbullarda.com  
www.bullardoutdoor.com



991 South Gull Lake Dr  
Richland, MI 49083  
USA

1-877-964-4646

**PHOTOMETRIC (Non anti glare louver)**

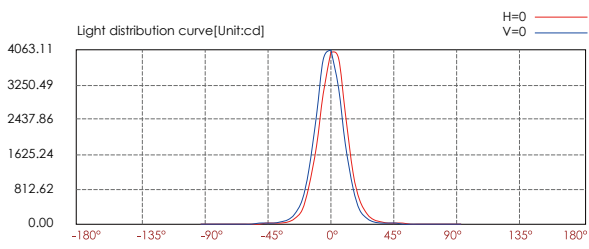
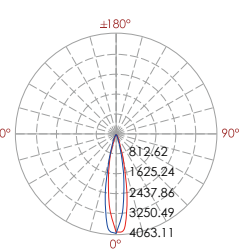
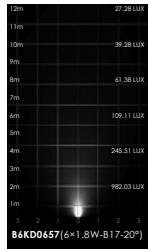

Lux distance cure

Center beam LUX	Beam width V	H
2m	982.03 LUX	0.7m 0.8m
4m	245.51 LUX	1.5m 1.5m
6m	109.11 LUX	2.2m 2.3m
8m	61.38 LUX	3.0m 3.0m
10m	39.28 LUX	3.7m 3.8m
12m	27.28 LUX	4.5m 4.5m

Ver.Spread: 21.2 Horiz.Spread: 21.4

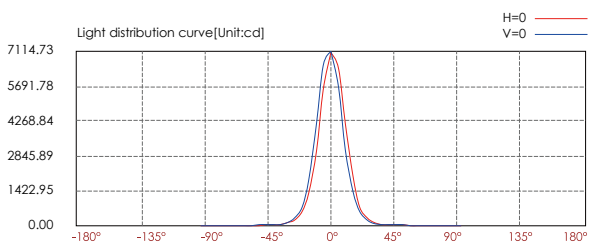
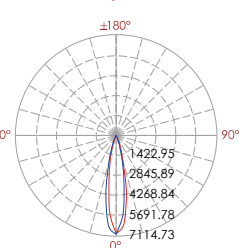
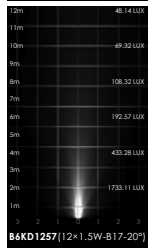

Lux distance cure

Center beam LUX	Beam width V	H
2m	1733.11 LUX	0.7m 0.7m
4m	433.28 LUX	1.4m 1.4m
6m	192.57 LUX	2.2m 2.2m
8m	108.32 LUX	2.9m 2.9m
10m	69.32 LUX	3.6m 3.6m
12m	48.14 LUX	4.3m 4.3m

Ver.Spread: 20.5 Horiz.Spread: 20.6

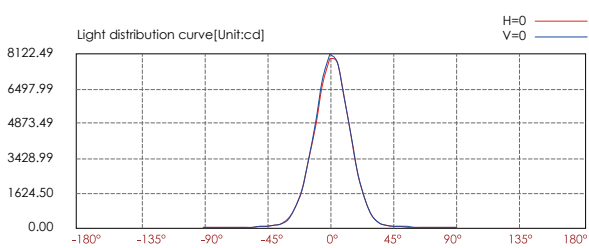
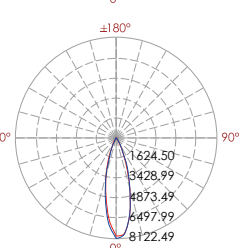
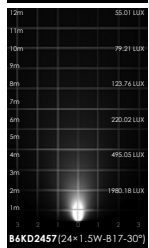

Lux distance cure

Center beam LUX	Beam width V	H
2m	1980.18 LUX	1.0m 1.0m
4m	495.05 LUX	2.0m 2.0m
6m	220.02 LUX	2.9m 3.0m
8m	123.76 LUX	3.9m 4.0m
10m	79.21 LUX	4.9m 5.0m
12m	55.01 LUX	5.9m 6.0m

Ver.Spread: 27.6 Horiz.Spread: 27.9

sales@gordonbullarda.com  
www.bullardoutdoor.com  
1-877-964-4646



991 South Gull Lake Dr  
Richland, MI 49083  
USA

Due to the dynamic nature of lighting products and the associated technologies, luminaire data on all sheet sheets is subject to change at the discretion of Gordon Bullard LLC and associated companies.

# LUSTER COLLECTION

## HOW TO ORDER:

CODE:

**EXAMPLE:**

BO-B6KD0657-WL-K35-A-C-6001#

BO-B6KD0657-WL-K35-A-C-6001#

### 1. CHOOSE FIXTURE SIZE:

- BO-B6KD0657 -WL      SMALL
- BO-B6KD1257-WL      MEDIUM
- BO-B6KD2457-WL      LARGE

### 2. CHOOSE CCT

- K30 -                      3000K
- K35 -                      3500K
- K40 -                      4000K
- K50 -                      5000K
- CUS\* -                    Custom on request

### 3. WATER PROOF SOLUTIONS: (included)

-A-C



### 4. WATER PROOF SOLUTIONS: (optional)

-B

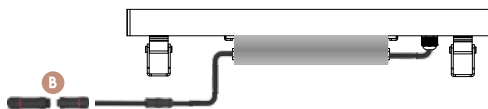

### 5. ANTI GLARE LOUVER (Optional)

-6001#



CODE: BO-B6KD0657 -WL



CODE: BO-B6KD1257-WL



CODE: BO-B6KD2457-WL

